

DECOMPOSITION OF A 3D TRIANGULAR MESH INTO QUADRANGULATED PATCHES

Roseline Bénéière, Gérard Subsol, William Puech
LIRMM, Univ. Montpellier 2, CNRS, 161 rue Ada, 34392, France
roseline.beniere@lirmm.fr; gerard.subsol@lirmm.fr; william.puech@lirmm.fr

Gilles Gesquière
LSIS, Aix-Marseille University, CNRS, IUT, BP 90178, 13637 Arles Cedex, France
gilles.gesquiere@Isis.org

François Le Breton
C4W, 219 rue Le Titien 34000 Montpellier, France
flb@c4w.com

Keywords: Remeshing, Quadrangular mesh, Quads quality, Parametrization.

Abstract: In this paper we present a method to decompose a 3D triangular mesh into a set of quadrangulated patches. This method consists in merging triangles to obtain quads. The quads are then grouped together to compose quadrangulated areas and patches. Unlike many methods of remeshing, this method does not move the vertices of the original triangular mesh. Quadrangulated patches extracted can then be used as a support of a parametric function or of a subdivision scheme.

1 INTRODUCTION

In Computer Aided Design (CAD), numerical calculation or simple data exchange, it may be necessary to discretize a 3D object to obtain a triangular mesh. However, for many applications, a parametric representation of these objects must be found. This topic has been studied for many years. One way to solve this problem is to calculate quadrangulated patches which are then used to support parametric surfaces, as shown in (Krishnamurthy and Levoy, 1996).

However, finding quadrangulated patches may be useful for other applications. Thus (Arden, 2001) shows the importance of these patches to use subdivision methods, as the Catmull-Clark algorithm (Catmull and Clark, 1978). The decomposition into quadrangulated patches can also be used for Finite Elements methods (Frey and George, 1999). Finally, in the context of reverse engineering where we want to find a CAD model composed of parametric surfaces, searching such patches is essential (Bommes et al., 2009a).

This paper is focused on this problem with the three following constraints:

- The original vertex positions of the 3D triangular mesh must be preserved and new vertex must not be added. We assume indeed that these positions were determined by metrology, or were computed directly from discretized CAD models

or were generated by numerical computation.

- The edges of the quadrangulated mesh must be derived from the triangulated mesh (see Figure 1(b)). This ensures that the final mesh will not contain any incoherent junction, like, for example, a T-junction where two edges cut themselves in a point which is not a vertex of the mesh.
- The quadrangulated mesh must be decomposed into patches which are rectangular grids with the same number of rows for each column (see Figure 1(c)). This will then allow us to encode the object in a standard format used in CAD as IGES (Initial Graphics Exchange Specification).

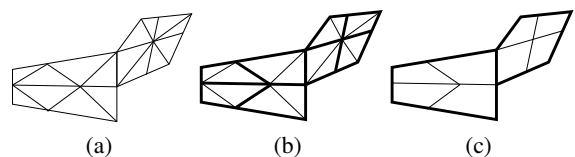

Figure 1: Extraction of quadrangulated patches: a quadrangulated mesh is computed from the triangulated mesh (b). The quadrangulated mesh is then decomposed into patches (c).

A study of existing methods is proposed in Section 2 and shows some of their limitations. A new method of decomposition into quadrangulated patches is presented in Section 3. Some results are shown in section

4, and future work is explored in Section 5.

2 PREVIOUS WORK

We choose to classify the methods for creating a quadrangulated mesh from a triangulated mesh into the three following classes.

2.1 The remeshing algorithms

In these methods, the position of the vertices are not preserved. The idea of quadrangulated remeshing is not recent (see for example (Hormann and Greiner, 2000)) but new methods called “Quad dominant remeshing” have emerged these last years. In 2003, Alliez and *al.* (Alliez et al., 2003) propose to compute the principal directions at each regular point of the surface. The curvature lines which are the integral lines of the principal directions allow to draw a quadrangulated grid on the surface. This method has been extended and for example, Dong and *al.* proposed to use harmonic functions (Dong et al., 2005). A synthesis of these methods is presented in (Alliez et al., 2007) and recent algorithms can be found in (Bommes et al., 2009b), (Lai et al., 2009), (Dong et al., 2006) or (Huang et al., 2008). Notice that many papers mention the T-junction problem which requires a post-processing to avoid inconsistencies in the resulting meshes.

2.2 The advancing front algorithms

The most representative method is Q-Morph (Owen et al., 1998). The idea is to propagate the construction of quads from the outlines to the center of the triangulated mesh. The resulting quads are based on the edges of the triangulated mesh. However, they are smoothed and their vertices are not anymore similar to the original ones. Furthermore, this method raises some problems in the case of closed meshes and recently a solution has been proposed (Miyazaki and Harada, 2009). In this method, the authors segment the mesh into areas, based on the vertex normals and they apply the Q-Morph method to these areas.

2.3 The merging algorithms

These methods come from the numerical analysis field. Their aim is to merge triangles of the mesh into quads to perform numerical computing, in general by Finite Element methods. Most of these algorithms work only with 2D meshes but (Borouchaki et al., 1997) presents a simple and modular presents for 3D

meshes. This method is based on triangle merging with respect to a quality coefficient. As (Tarini et al., 2010), we have adapted and developed this idea to obtain the first step of our decomposition algorithm.

2.4 Conclusion

All these methods create quadrangulated meshes which are not composed of the original vertices and edges of the initial triangular mesh. Furthermore, they do not lead to a direct and explicit decomposition into patches even if some methods as (Eppstein et al., 2008) have been proposed.

In this paper, we present a straightforward method that combines both steps: quadrangulation and decomposition into patches.

3 OUR METHOD

In this section we describe a new method of decomposition into quadrangulated patches which is composed of three steps:

- a coefficient which defines the quality of a quad created by merging two triangles is computed for each pair of adjacent triangles;
- quadrangulated areas are then built by aggregating the quads according to values of the quality coefficient;
- quadrangulated areas are then decomposed into quadrangulated patches.

3.1 Quads Creation

The first step consists in creating quads based on the triangulated mesh. These quads should be built using only vertices and edges of the original mesh. A quad is defined by merging two adjacent triangles. A triangle can lead to the creation of up to three quads, one by edge, so a choice should be made.

As in (Borouchaki et al., 1997), this choice should be based on a quality coefficient computed for each pair of adjacent triangles. In our method, we want to give high priority to quads which are similar to planar rectangles. In this case, each angle α_i of the quad is close to $\frac{\pi}{2}$ and the dihedral angle ϕ between the two triangles constituting the quad is close to π (see Figure 2). So, a quality coefficient Q can be defined by:

$$Q = \begin{cases} 2\pi & \text{if } \phi < \phi_{min} \\ \frac{1}{4} \sum_{i=1}^4 \left| \frac{\pi}{2} - \alpha_i \right| & \text{else .} \end{cases} \quad (1)$$

Thus, this coefficient equals to the average difference between each angle and $\frac{\pi}{2}$. Thus a quad which is similar to a rectangle will have a coefficient close to 0.

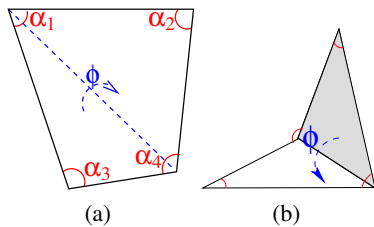

Figure 2: (a) The quality coefficient Q is computed with the α_i (in red) which are the angles at the quad vertices and the dihedral angle ϕ (in blue). (b) A large dihedral angle and α_i far from $\frac{\pi}{2}$ implies a “bad” quality.

Moreover, if the dihedral angle is smaller than a tolerance ϕ_{min} , the quad will be flagged as “incorrect” as in Figure 2(b). Similarly, the quads which have a quality coefficient greater than the tolerance Q_{max} are not used to build quadrangulated areas.

3.2 Extraction of Quadrangulated Areas

The aim of this step is to extract quadrangulated areas using the quality coefficient presented in the previous section.

In the first step, to initialize the process, the quad with the best quality coefficient is chosen. The quadrangulated area is propagated iteratively by adding at each step the quad having the best quality coefficient among the neighborhood of the area in construction.

To find this quad, all potential quads containing an adjacent triangle with an edge of the area outline are examined. For example, in Figure 3(b), the hatched triangles are examined to find the next quad of the quadrangulated area.

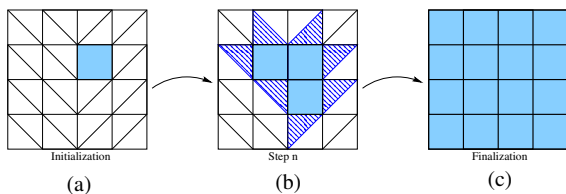

Figure 3: Iterative extraction of a quadrangulated area: initialization with the quad having the best quality coefficient (a); at each step a quad is added (b); the process stops when there is no quad to be added anymore (c)

The propagation is stopped when there is no neighboring triangles anymore, or if the triangle is isolated, or if the neighboring triangles can only create quads with a quality coefficient larger than Q_{max} .

When an area is finalized, a new area is initialized, with the quad having the best quality coefficient in the part of the triangulated mesh not used yet.

Thus from a triangulated mesh, one or more quadrangulated areas are obtained. For example, only one quadrangulated area has been extracted from the mesh in Figure 4. However, all triangles are not used, the left triangles correspond to isolated triangles or triangles which can only lead to quads with a quality coefficient larger than Q_{max} .

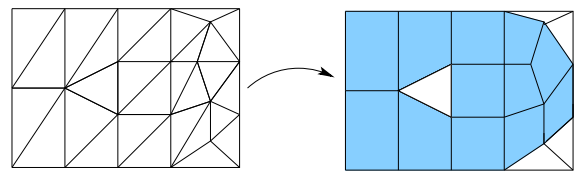

Figure 4: Extraction of a quadrangulated area from a triangulated mesh. The left triangles do not enable to create a quad having a good quality.

3.3 Decomposition into Quadrangulated Patches

After the quadrangulated area process, a decomposition into sub-areas which are called “rectilinear polygons” begins. For this purpose, a unique position is assigned to each quad. This position consists in a line number and a column number which will allow to define the rectilinear polygons.

The quad having the best quality coefficient is chosen in the quadrangulated area. It is labeled with the position (0, 0). Positions are then propagated to its four neighbors, as in the Figure 5.

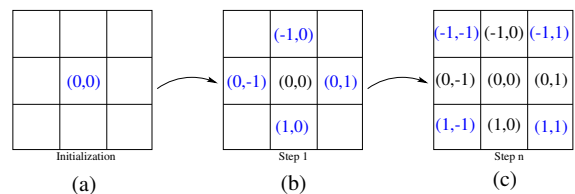

Figure 5: Propagation of the position from the first quad to its neighbors.

When a position is assigned to each quad, a rectilinear polygon is defined using the positions to store the quads at a correct place in a regular grid.

Creating the rectilinear polygon by assigning a position to each quad in relation to the position of its

neighbors can lead to ambiguities. Thus, the first chosen quad in Figure 6 is quad 1, the positions of quads 2, 3, 4, 5 and 7 are easily deduced afterward. The problem is with the quad 6 which would have both the position (1, 2) as a neighbor “down” of the quad 5 and the position (0, 2) as a neighbor “up” of the quad 7. Furthermore, these two positions are already assigned. There will be another problem with quad 11 which has two different positions assigned, one as the “right” neighbor of quad 8 and one as the “right” neighbor of quad 9.

Such ambiguities occur when the vertices of the quadrangulated area are not of valence 4. In the example of Figure 6, a valence 3 vertex and a valence 5 vertex raise the position attribution problems.

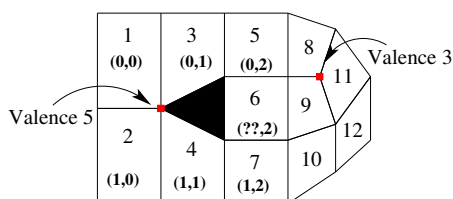

Figure 6: Decomposition into “rectilinear polygons” with ambiguity positions with the quads 6 and 11.

To avoid this, some tests were added to check if two quads have not the same position or if two positions are not assigned to the same quad. If any of these cases occur, the rectilinear polygon is decomposed into two polygons. Thus the quadrangulated mesh of Figure 6 is decomposed into three rectilinear polygons as in Figure 7.

Rectilinear polygons containing only one quad are not kept, like the rectilinear polygon with the single quad 11 in Figure 7. Its two triangles remain then in the triangulated mesh.

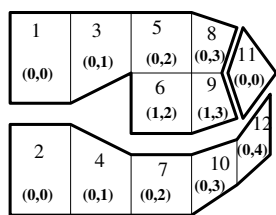

Figure 7: Decomposing the quadrangulated area into 3 rectilinear polygons.

The last step enables to decompose the rectilinear polygons into patches, which are rectangular grids having the same number of lines for each column.

An iterative method is used to perform this. Initially, the patch with the greatest number of quads is computed. The quads of the patch are removed from

the rectilinear polygon. A new patch with the greatest number of quads can be then searched in the new rectilinear polygon. The process is stopped when no quad is left in the rectilinear polygon.

To find the patch with the greatest number of quads in the rectilinear polygon, each quad of the rectilinear polygon is examined. For a quad, all patches having this quad at “left upper corner” are computed. Such a computation of patches is based on browsing along only two directions (\rightarrow and \downarrow), because the two other directions were already examined by browsing from the previous quads. The longest line (\rightarrow) from the quad is computed. Then, the number of lines having the same length existing down (\downarrow) is determined. In Figure 8, from the quad q , the longest possible line includes five quads, and lines of five quads are possible only on both lines. Finally, the patch with the greatest number of quads among all patches computed for each quad is selected.

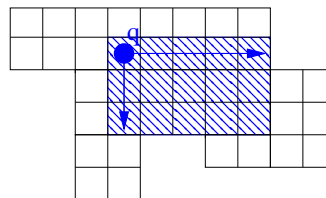

Figure 8: Patch construction in a rectilinear polygon from quad q .

Nevertheless, this method does not guarantee that the number of patches is minimal at the end of the process. Thus in Figure 9, extracting initially the patch with the greatest number of quads (hatched in blue), the rectilinear polygon is decomposed into three patches whereas only two would be necessary to cover the whole it.

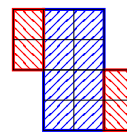

Figure 9: Case where our method does not give an optimal covering: we obtain three patches while two would be sufficient.

However we decide to keep this simple approach even if some methods exist to optimize the number of patches dissecting the rectilinear polygon as for example in (Soltan and Gorpinevich, 1993).

Finally, the three steps lead to three quadrangulated patches, shown in Figure 10. Notice that a part of the triangulated mesh is not used. This is due to isolated triangles, quads of which $Q > Q_{max}$, or quads

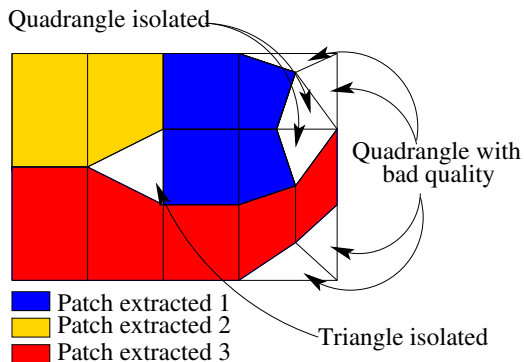

Figure 10: Decomposition into quadrangulated patches from a triangulated mesh.

isolated during the creation of the rectilinear polygons.

4 EXPERIMENTAL RESULTS

Our method has been implemented in the software *3D Shop* of the *C4W*¹. This software gives efficient development tools for 3D modeling and visualization².

Figures 11 (*Bunny*), 12 (*Face*), 13 (*Fandisk*), 14 (*Smurf*³), 15 (*CubeCylinders*) and 16 (*Torus*) show some results obtained on triangulated meshes coming from various sources as CAD for *CubeCylinders* and *Torus*, infography for *Face* and *Smurf* or 3D digitization for *Bunny* and *Fandisk*. Each result is constituted of the extracted quadrangulated patches (in blue) and of remaining triangles (in green). Table 1 gives for each mesh, the number of triangles, the number of extracted patches and the covering percentage that corresponds to the percentage of original triangles covered by quadrangulated patches.

On *Bunny*, *Face* and *Fandisk*, the quadrangulated patches cover a large part of the mesh. That enables to obtain a reduction factor between the triangle number and the patch number which reaches 30. Effective coding in CAD format based on the face concept (like IGES) can be envisaged.

Nevertheless, some patches have a small size and to cover 80% of the 5,590 triangles of the mesh *Face*, 335 patches are used. The decomposition of some areas into small patches comes from a few triangles

¹C4W is a company which develops innovative CAD solutions and support this Ph.D. Thesis work (<http://www.c4w.com>)

²www.c4w.com/3d-cad-software.html

³<http://www.3dvalley.com/3d-models/characters>

or quads which are isolated and lead to decompose a large potential patch into several smaller ones.

To avoid this and to create larger patches, we experimented different values for the parameters Q_{max} and ϕ_{min} because these thresholds may limit the propagation process during the construction of quadrangulated areas. The values Q_{max} and ϕ_{min} were empirically fixed to respectively $\frac{\pi}{2}$ and $\frac{5\pi}{6}$, for all tests except on the mesh *Smurf*.

For the mesh *Smurf* in Figure 14, the value Q_{max} is fixed successively to $\frac{\pi}{2}$, π and 2π . The threshold ϕ_{min} has been modified in the last case to 2π : in this case, all potential quads have been then considered. Figure 14, with the mesh *Smurf*, which have 64,320 triangles, shows the patches evolution. Some areas like the eyes, the hands or the shoulder contain many triangles which are not used. The number of unused triangles decreases when the thresholds are modified. The number of patches decreases too and the covering percentage increases. These new results arises because the patch shapes can change dramatically by adding only one new quad as in Figure 14.

However, it is necessary to take care of the quadrangulated patches which can then contain some quads with low quality. This may engender problems to some applications, for example in numerical calculation. Moreover even when we set both thresholds to 2π , there are always left triangles. Indeed, there are triangles isolated in the quadrangulated areas construction and quads isolated in the rectilinear polygons construction. On the quadrangulated areas containing many vertices which are not valence 4, these quads can very be numerous and may lead to lots of small rectilinear polygons.

Finally, we have tested our method on 3D simple objects, like the union of a cube and two cylinders (figure 15). The result of the decomposition from the mesh *CubeCylinders*, is satisfying because more than 95% of the mesh is covered with only 21 patches which corresponds to a reduction factor of more than 130. However in the case of a simply torus like Figure 16, our method finds one patch which covers 100% of the object. The method is really adapted to CAD meshes composed by simple primitives. In fact our method has good result on the CAD mesh because the discretization of the mesh has often a first step of quadrangulation which was then triangulated.

5 CONCLUSION AND PERSPECTIVES

In this paper, we have presented a method enabling to decompose 3D triangulated meshes into

Mesh	Triangles in mesh	Extracted patches	Covering percentage
Bunny	69,451	1,932	89.98%
Face	5,590	335	80.32%
Fandisk	23,964	720	88.66%
Smurf	64,320	931	91.39%
CubeCylinders	2,608	21	95.47%
Torus	9,384	1	100%

Table 1: Results on different 3D triangular meshes

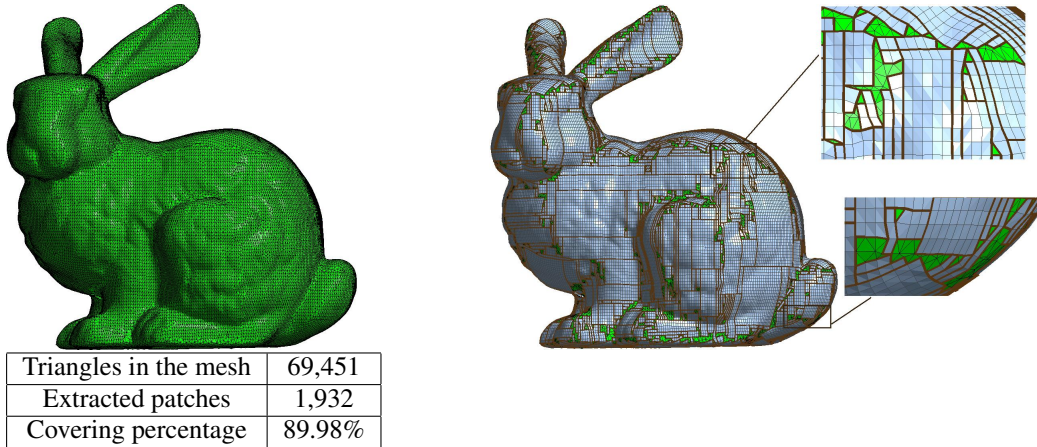

Figure 11: Original mesh and result for: *Bunny*.

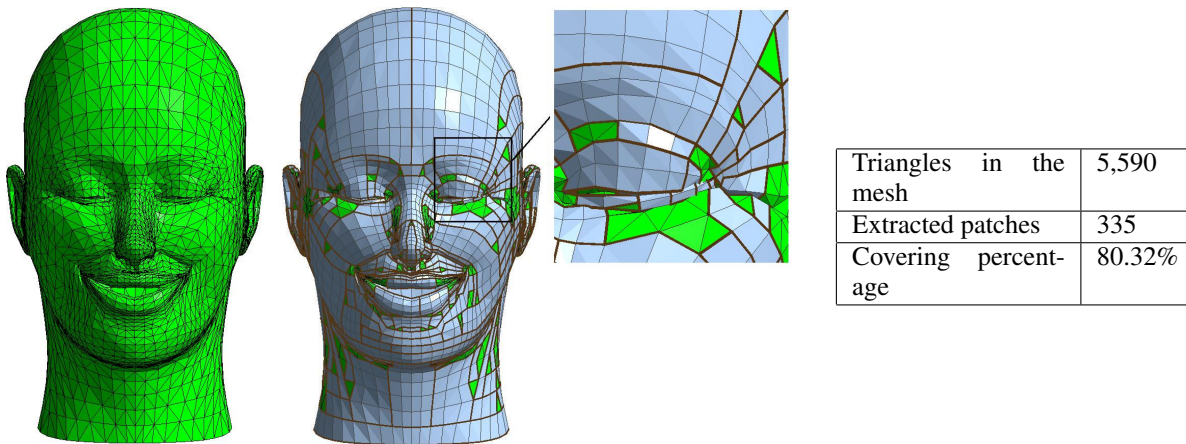

Figure 12: Original mesh and result for: *Face*.

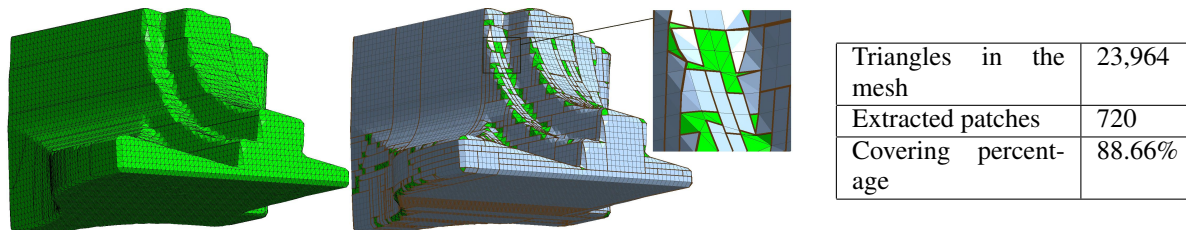
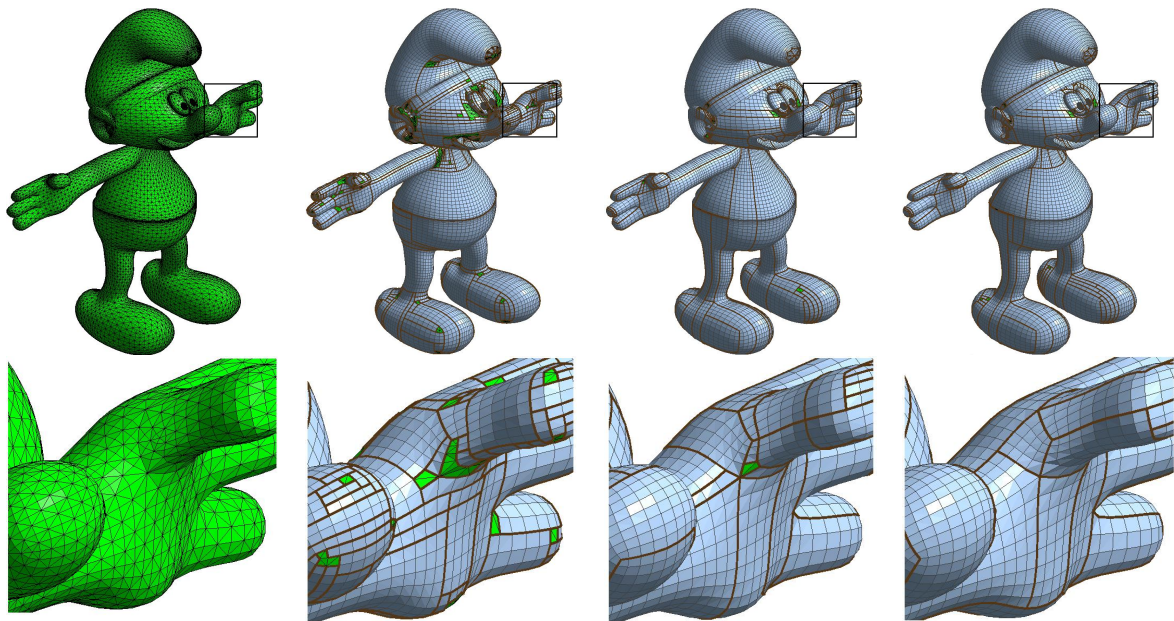
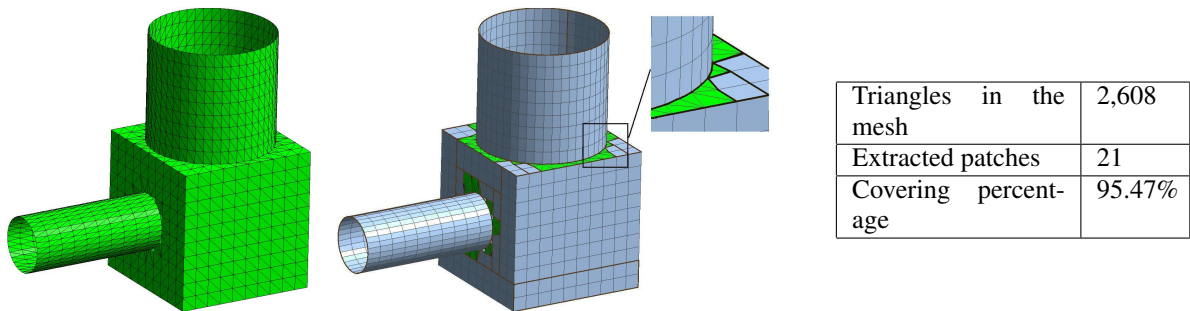

Figure 13: Original mesh and result for: *Fandisk*.



Q_{max}	ϕ_{min}	Number of patches	Covering percentage
$\frac{\pi}{2}$	$\frac{5\pi}{6}$	931	91.39%
π	$\frac{5\pi}{6}$	519	98.52%
2π	2π	502	98.56%

Figure 14: The mesh *Smurf* with a zoom mesh and the obtained results with $Q_{max} = \frac{\pi}{2}, \pi$ and 2π (left to right). The number of patches decreases and their sizes increase. So the covering with the decomposition is better on this example.



Triangles in the mesh	2,608
Extracted patches	21
Covering percentage	95.47%

Figure 15: Original mesh and result for: *CubeCylinders*.

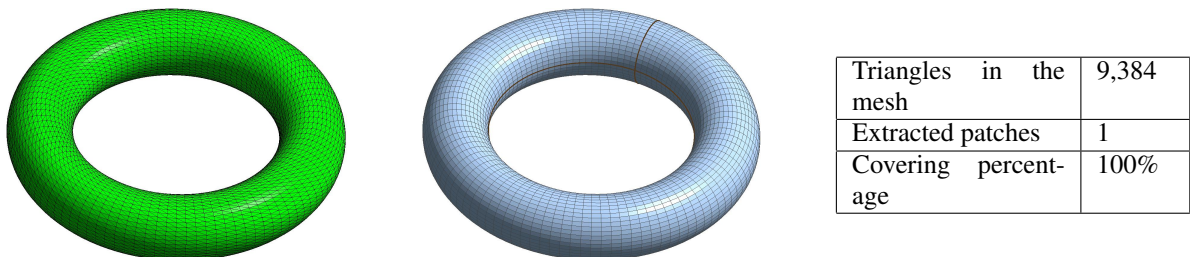

Triangles in the mesh	9,384
Extracted patches	1
Covering percentage	100%

Figure 16: Original mesh and result for: *Torus*.

quadrangulated patches, without modifying the vertex position. Our method is based on merging adjacent triangles to create quads satisfying a quality criterion. Quads are then aggregated into quadrangulated areas

which are finally decomposed into patches.

This decomposition into quadrangulated patches can be used in many applications such as the creation of parametric surfaces, subdivision, or the numerical

calculation.

Comparison with other existing methods, quadrangulation and decomposition ones, should be made.

The proposed method can be improved in each of its three steps. First, defining other quality coefficients could improve the extraction of quadrangulated areas. According to computed parameters on the complete mesh, averages of angles computed for all the vertices seems to be a good way. The constraints can also be adjusted according to its local “shape”, by relaxing for example the constraints of the dihedral angle in the most curved part of the object.

Other propagation algorithm for the creation of quadrangulated areas, can be proposed or the research of rectilinear polygons can be optimized. The objective of these two modifications would be to decrease the number of isolated triangles.

Another possible improvement would be to avoid the step of extracting rectilinear polygons, and to decompose directly quadrangulated areas into patches. This would enable to optimize globally the process and to decrease the number of patches constituted by a single quad which do not belong to the final decomposition.

A last step of patch merging could be added and it would enable to group two patches in only one, integrating if it is necessary adjacent isolated quads. If it does not improve the percentage of covering, it will decrease the number of patches of the decomposition.

Finally, some feature lines could be used, as the “ridge lines” to define potential boundaries for patches. The decomposition would be then optimized using this knowledge as it is done in several remeshing algorithms.

ACKNOWLEDGEMENTS

The authors want to thank the C4W company and the Association Nationale de la Recherche et de la Technologie (ANRT) for their financial support.

REFERENCES

- Alliez, P., Cohen-Steiner, D., Devillers, O., Lvy, B., and Desbrun, M. (2003). Anisotropic polygonal remeshing. *ACM Transactions on Graphics, SIGGRAPH 2003 Conference Proceedings*, 22(3):485–493.
- Alliez, P., Ucelli, G., Gotsman, C., and Attene, M. (2007). Recent advances in remeshing of surfaces. In *Shape Analysis and Structuring*, pages 53–82. Springer Berlin Heidelberg.
- Arden, G. (2001). *Approximation Properties of Subdivision Surfaces*. PhD thesis, University of Washington.
- Bommes, D., Vossemer, T., and Kobbelt, L. (2009a). Quadrangular parametrization for reverse engineering. *Lecture Notes in Computer Science (to appear)*.
- Bommes, D., Zimmer, H., and Kobbelt, L. (2009b). Mixed-integer quadrangulation. *ACM Trans. Graph.*, 28(3):1–10.
- Borouchaki, H., Frey, P. J., and George, P. L. (1997). Maillage de surfaces paramétriques. Partie III: Eléments quadrangulaires. 325(1):551–556.
- Catmull, E. and Clark, J. (1978). Recursively generated B-spline surfaces on arbitrary topological meshes. *Computer-Aided Design*, 10(6):350–355.
- Dong, S., Bremer, P.-T., Garland, M., Pascucci, V., and Hart, J. C. (2006). Spectral surface quadrangulation. *ACM Trans. Graph.*, 25(3):1057–1066.
- Dong, S., Kircher, S., and Garland, M. (2005). Harmonic functions for quadrilateral remeshing of arbitrary manifolds. *Computer Aided Geometry Design, Special Issue on Geometry Processing*, 22(5):392–423.
- Eppstein, D., Goodrich, M. T., Kim, E., and Tamstorf, R. (2008). Motorcycle graphs : Canonical mesh partitioning. *Comput. Graph. Forum*, 27(5):1477–1486.
- Frey, P. J. and George, P. L. (1999). *Maillage : Applications aux éléments finis*.
- Hormann, K. and Greiner, G. (2000). Quadrilateral remeshing. In Girod, B., Greiner, G., Niemann, H., and Seidel, H.-P., editors, *Proceedings of Vision, Modeling, and Visualization 2000*, pages 153–162, Saarbrücken, Germany.
- Huang, J., Zhang, M., Ma, J., Liu, X., Kobbelt, L., and Bao, H. (2008). Spectral quadrangulation with orientation and alignment control. *ACM Trans. Graph.*, 27(5):1–9.
- Krishnamurthy, V. and Levoy, M. (1996). Fitting smooth surfaces to dense polygon meshes. In *Proceedings of SIGGRAPH 96*, pages 313–324.
- Lai, Y.-K., Kobbelt, L., and Hu, S.-M. (2009). Feature aligned quad dominant remeshing using iterative local updates. *Computer-Aided Design (to appear)*.
- Miyazaki, R. and Harada, K. (2009). Transformation of a closed 3D triangular mesh to a quadrilateral mesh based on feature edges. *IJCSNS International Journal of Computer Science and Network Security*, 9(5).
- Owen, S. J., Staten, M. L., Canann, S. A., and Saigal, S. (1998). Advancing front quadrilateral meshing using triangle transformations. *7th International Meshing Roundtable*, pages 409–428.
- Soltan, V. and Gorpinevich, A. (1993). Minimum dissection of a rectilinear polygon with arbitrary holes into rectangles. *Discrete and Computational Geometry*, 9(1):57–59.
- Tarini, M., Pietroni, N., Cignoni, P., Panozzo, D., and Puppo, E. (2010). Practical quad mesh simplification. *Computer Graphics Forum*, 29(2):To appear.